

ORBIS Europe

INNOVATIVE PACKAGING SOLUTIONS
...for a sustainable future

ORBIS[®]

Powered by Menasha Corporation

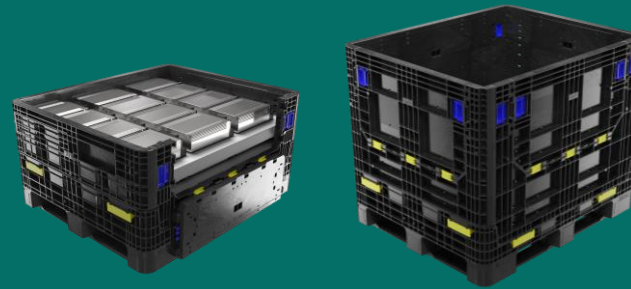

DISCLAIMER: These materials are proprietary, confidential, for discussion purposes only, and intended solely for the use of ORBIS Corporation ("ORBIS"), its affiliates, and their respective shareholders, directors, officers, and employees. ORBIS disclaims any express or implied warranties concerning the accuracy, reliability, or completeness of, and accepts no liability for, any information contained herein. Any views or opinions presented herein are solely those of the author(s) and do not necessarily represent those of ORBIS. If you are not the intended recipient please notify ORBIS immediately and destroy all copies. Unauthorized use or dissemination of these materials is strictly prohibited.



INNOVATIVE



DURABLE



SUSTAINABLE



AGENDA



About ORBIS



Product & Service Portfolio



Sustainability

ABOUT ORBIS

- ORBIS is a subsidiary of Menasha Corporation
- Family-owned business since 1849 with more than 170 years of experience
- World Headquarters: Oconomowoc, Wisconsin
- 2 Bill. € Revenue / 7.500 employees worldwide (Menasha)
- ORBIS Manufacturing facilities in EUROPE, USA, MEXICO and CANADA







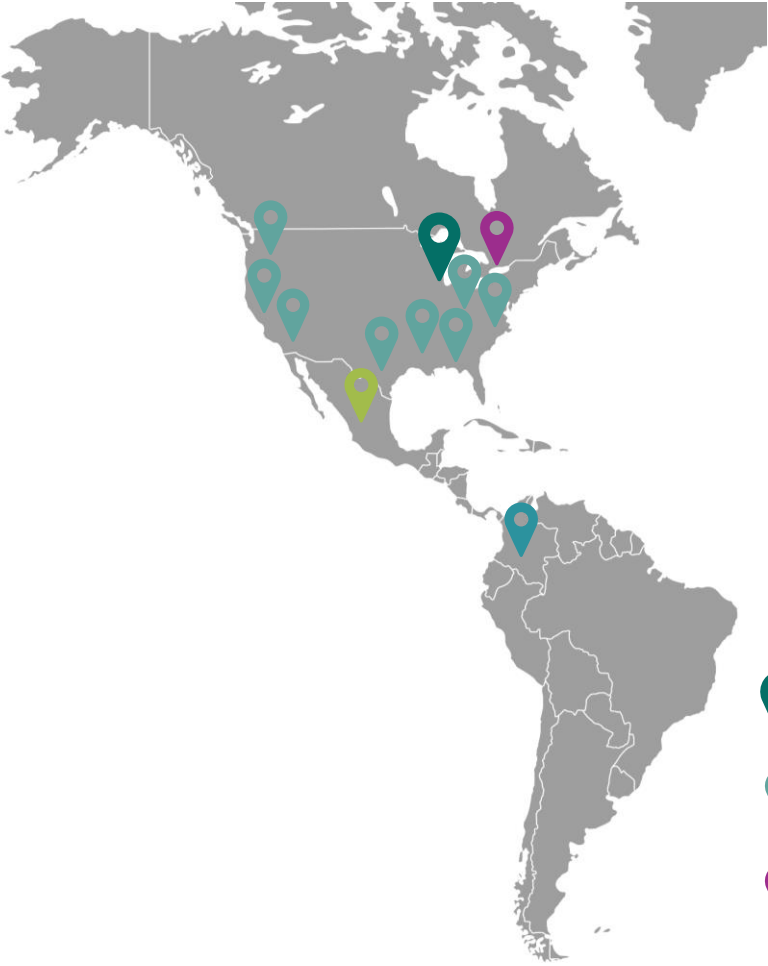

POWER BEHIND POSSIBLE

- The Menasha Corporation is Family-Owned for **7 Generations**
- Founded in 1849
- Sister Company: Menasha Packaging
- 7,500 Employees, 100+ Locations
- A Legacy of **Social Responsibility** – 3-Tiered Approach:
 - Economic Value
 - Social Responsibility
 - Environmental Stewardship and Circular Economy



LOCATIONS



-  Oconomowoc, Wisconsin
US Headquarters
-  Unites States of America
Production, Sales, RPM Service Centers
-  Toronto, Ontario, Canada
Production
-  Mexico
Production, Sales, RPM Service Center
-  Columbia
Sales FMCG and Beverage

In Europe since 2016

-  Hürth / Cologne, Germany
European Headquarters
-  Ieper, Belgium
Production
-  Eindhoven, The Netherlands
RPM Service Center



SOLUTIONS FOR GLOBAL SUPPLY CHAINS



Automotive



Battery



Industrial

e.g. agricultural machinery, railway



Beverage



Food



FMCG

WHY REUSABLES



ORBIS EUROPE SERVICE OFFERING

Integrated solutions to meet your supply chain needs



Expanding Range of Reusable Packaging Solutions



Unbiased Design Solutions and Customer-Specific Developments



Global Team of Universal Subject Matter Experts



Reusable Packaging Management Solutions (availability based on project)



Global Coverage



Engineering Services

Leading in USA, Canada and Mexico – growing presence in Europe

PRODUCT PORTFOLIO – RSC



Food & Beverage Pallets

- For aluminium cans, glass/plastic bottles
- Load capacity 10.000 kg static
- Layer pads and top frames available
- Different footprints available

Services

- Qualified consulting
- Customer-specific packaging solutions
- Global support

PlastiCorr®

- Drop-in replacement for fibre corrugated boxes in automated packaging lines
- No changes to pack count and logistics needed
- Repeatable, reliable performance
- Applications: inbound, finished goods

PRODUCT PORTFOLIO – INDUSTRIAL



BulkPak® – Industrial Bulk Bins

- Efficient alternatives to conventional packaging, e.g. metal / wood boxes
- Standard footprints:
1200 x 800 / 1200 x 1000 / 1600 x 1200
- Weight capacity of up to 900 kg
- Foldable and stackable design

IonPak® – Dangerous Goods Packaging

- UN-Certified plastic container with inner packaging
- Certified to transport solid dangerous goods
- Approval up to 477-915 kg gross weight
- Different footprints available

Services

- Qualified consulting e.g. by certified dangerous goods advisors
- Customer-specific packaging solutions
- Global support

PRODUCT PORTFOLIO – NORTH AMERICA



Bulk Packaging

- Strength and rugged durability for industrial/automotive applications
- Foldable and stackable design
- Footprints from 32" x 30" to 78" x 48"
- Available in many styles, e.g. collapsible

Hand-Held Containers/Totes/Bins

- Reduces waste associated with single-use boxes
- Drives automation efficiency and improves worker safety
- Footprints from 12" x 7" to 48" x 22"
- Available in many styles, e.g. collapsible, nestable

Racking and Distribution Pallets

- Conversion from wood to plastic pallets
- For work-in-process, storage and distribution applications
- Footprints from 20" x 28 to 48" x 72"
- More than 150 different styles/models



ENGINEERING SERVICES & CUSTOM SOLUTIONS

- ✓ Reusable packaging programs for long-term savings and sustainability
- ✓ Environmental and economic analysis (e.g. LCA / TCO)
- ✓ Standard and customised container development
- ✓ In-house dunnage design capabilities for part protection and pack density (e.g. EPP)
- ✓ Qualified consulting according RID/ADR, incl. project management & UN certification

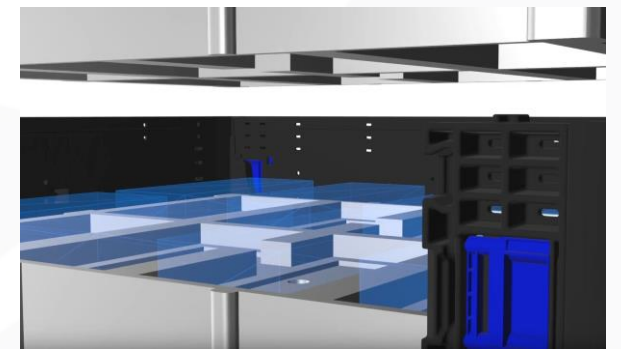
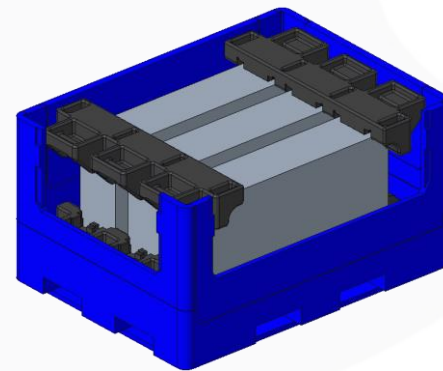

OUR CIRCULAR ECONOMY

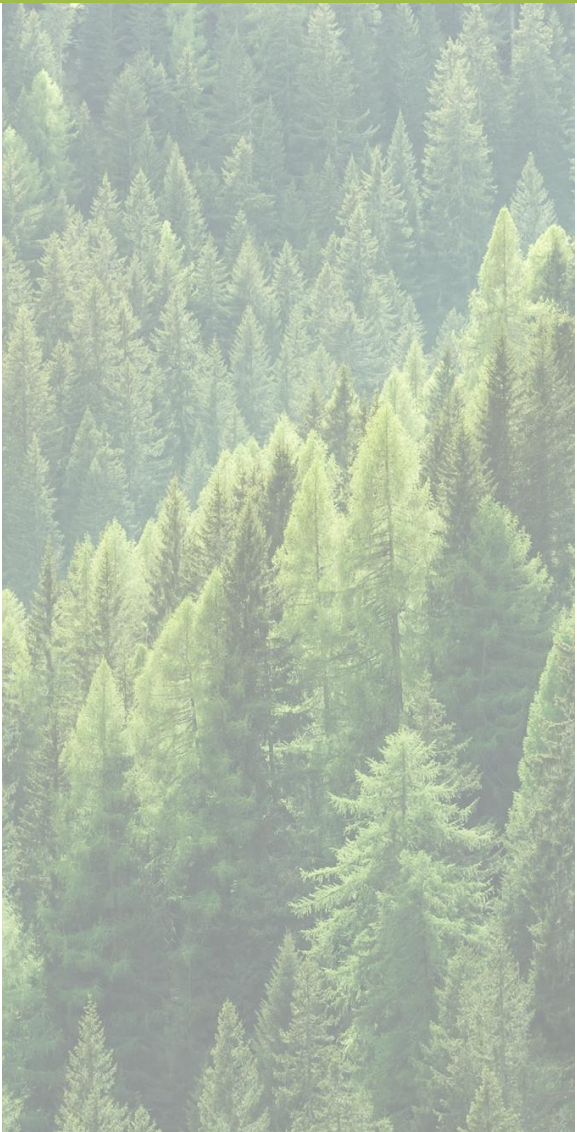

¹As proven using Franklin and Associates life-cycle data.

SUSTAINABILITY AT ORBIS

1. Green product design for more sustainable supply chains



REDUCE

Reusables are designed to lessen waste, emissions and energy use.¹



REUSE

Plastic packaging is durable and reusable over several years.



RECYCLE

Manufactured, used and recycled with no solid waste.



REPURPOSE

Recycled materials are repurposed for new production.

2. Reducing the use of resources in our own operations

Greenhouse gas emissions



Water usage



Solid waste



¹As proven using Franklin and Associates life-cycle data.

RECYCLE WITH ORBIS

- **Comprehensive recycling program** for the efficient recovery of obsolete and surplus packaging
- By design, plastic reusable packaging can be fully recycled and used in other useful products at the end of its service life – without entering the solid waste stream.
- Buyback option for end-of-life plastic packaging (HDPE & PP)
→ **Receive credit** for future purchases
- Exemplary calculation:
28,99€ net present value at time of purchase

Weight	Price / kg ¹	Credit	Transport ²	Disposal ³	Interest Rate	NPV
65 kg	0,58 €	37,70 €	5,68 €	0,00 €	1,0 %	28,99 €

¹ Based on value of 03/2022.

² Transportation from South Germany to ORBIS Plant Belgium: 1.500 € / 264 Bins = 5,68 € per Bin.

³ The raw materials are 100% recyclable, no disposal costs.



Connect with us!

INNOVATIVE PACKAGING SOLUTIONS
...FOR A SUSTAINABLE FUTURE



 **Powered by Menasha Corporation**



DISCLAIMER: These materials are proprietary, confidential, for discussion purposes only, and intended solely for the use of ORBIS Corporation ("ORBIS"), its affiliates, and their respective shareholders, directors, officers, and employees. ORBIS disclaims any express or implied warranties concerning the accuracy, reliability, or completeness of, and accepts no liability for, any information contained herein. Any views or opinions presented herein are solely those of the author(s) and do not necessarily represent those of ORBIS. If you are not the intended recipient please notify ORBIS immediately and destroy all copies. Unauthorized use or dissemination of these materials is strictly prohibited.